

SERIES CRUX 4

DESCRIPTION

Crux 4 is the wall cabinet of the barpa range of cabinets. It's available in a range of heights and depths and accommodates a load of up to 60 kg. The best way to get the most of this cabinet is with barpa accessories, you should get them separately. Order this product either assembled or in flat packs.

APPLICABLE STANDARDS

• ANSI/EIA RS-310-D; IEC60297-2; DIN41494 Part 1 and 7



PRODUCT SPECIFICATIONS

Color	Black (RAL 9004)
Material	SPCC Cold Rolled Steel; Mounting profile: 1.2mm; Others 1.0mm
Loading Capacity (kg)	60
Earth Connection	Yes
Product Family	Series Crux

FEATURES

Flat packing, mounting time less than 5 minutes
Cable entry on both of top cover and bottom panel
Perforated front door with lock
Safe installation through wall fixing with screws
19" standard installation with pre-installation of ventilation

ORDER INFORMATION

Pack 1							
Code	U	Width (mm)	Length (mm)	Height (mm)	Dimensions (mm)	Gross Weight (kg)	Net Weight (kg)
82324060604	6	450	570	370	420x620x230	14,5	13,5
82324060606		600	570	370	570x620x250	17,5	16,5
82324090604	9	450	570	500	560x620x210	17	16
82324090606		600	570	500	570x620x230	20,5	19,5
82324120604	12	450	570	635	690x620x190	21	20
82324120606		600	570	635	690x630x180	24,5	23,5
82324150604	15	450	570	770	820x620x180	24,0	23,0
82324150606		600	570	770	840x610x180	27,5	26,5
82324180604	18	450	570	900	960x620x180	28	27
82324180606		600	570	900	950x620x180	31	30
82324220604	22	450	570	1080	1130x620x180	32	31
82324220606		600	570	1080	1140x620x180	37	36

Note: To order the assembled rack, add "M" at the end of the code.

PACKAGING INFORMATION

Pack	Description	Quantity
1	Back Frame	1
	Side Frame	2
	Top Cover	1
	Bottom	1
	Front Frame	1
	Front Door	1
	Side Panel	2
	Mounting Rail	4
	Screws and Nuts	10 units (6U-12U) 20 units (15U-22U)
	Tools	1pc Spanner
	Instructions Manual	1

TECHNICAL DRAWING (mm)

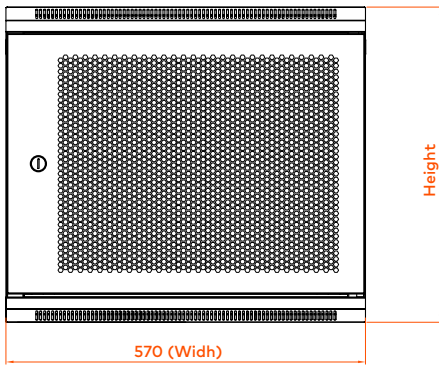

FRONT

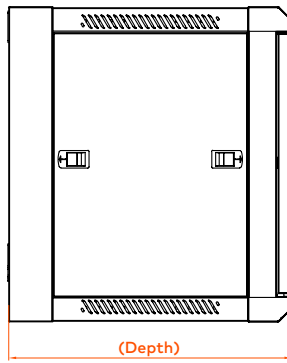

SIDE

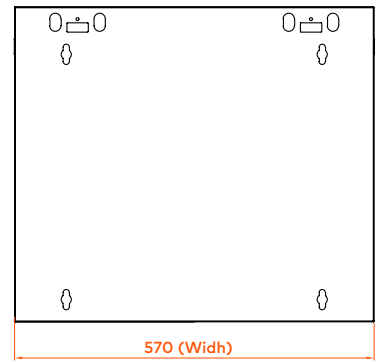

BACK

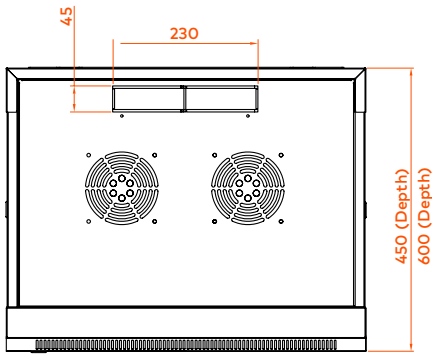

TOP

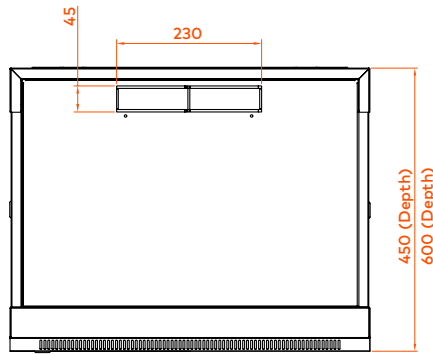

BOTTOM

PACKAGING

This images are merely illustrative.
We want you to see the importance we attach to the packaging.



To order the assembled rack, add "M" at the end of the code.
Please specify in your request.



As part of our goal to achieve quality excellence, our barpa System Warranty can give you 25 years products and solution assurance of compliance with the industry performance standard comparing with the class installed. This warranty applies to network infrastructure installations that was made by an approved barpa partner using an barpa solution (end-to-end). For more informations go to our website.