



## RACK CRUX 3 - 10"

### DESCRIPTION

Crux 3 cabinet is the wall mount bracket of the barpa range of cabinets. The best way to get the most of this cabinet is with barpa accessories, you should get them separately. Perfect for versatile solutions as small networks.

### APPLICABLE STANDARDS

- ANSI/EIA RS-310-D; • IEC 60297-2;
- DIN 41494 Parte 1 and 7.



### SPECIFICATIONS

Material	SPCC Cold Rolled Steel; Mounting profile: 1.2mm; Others 1.0mm
Loading Capacity (kg)	30
Color	Black (RAL9004)
Earth connection	Yes
Product Family	Series Crux

### FEATURES

Already mounted
Cable entry on both of top cover and bottom panel
Opening direction of door can be changed, turning angle of front door is over 180 degrees
Glass front door
Wall mounted panel, convenience for installation, locked from inside with screw, avoiding to be stolen or accidentally dropped
10" standard installation with pre-installation of ventilation

### ORDER INFORMATION

Product				Package			
Code	U	Width (mm)	Length (mm)	Height (mm)	Dimensions (mm)	Weight (kg)	EAN
82361080000	8	300	236,4	441	300x300x411	8.5	5608445014122

This document is authored and owned by barpa . It is forbidden to reproduce in whole or in part without mentioning its authorship, as well as modification of its content or context. All specifications are subject to change without notice. The pictures/drawings are merely illustrative.

More information: [info@barpa.eu](mailto:info@barpa.eu) or in [www.barpa.eu](http://www.barpa.eu)

### TECHNICAL DRAWING (mm)

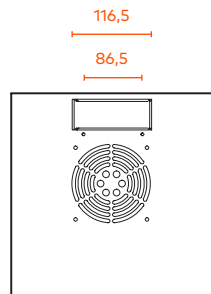
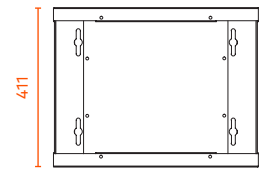
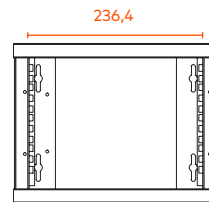
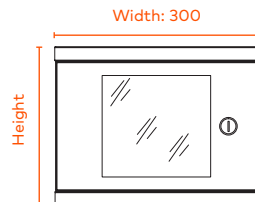
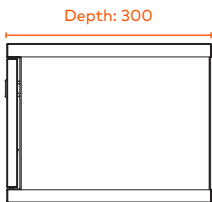
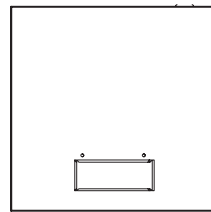
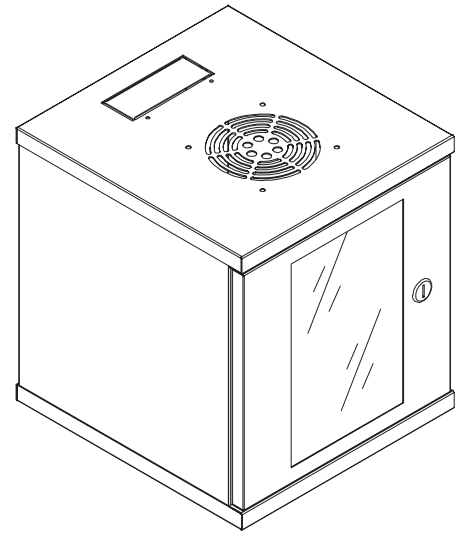

## PACKAGING

---

This images are merely illustratives. We want you to see the importance we attach to the packaging.  
We always work with products and materials that are easy to use.

